

1 Fold in half to make

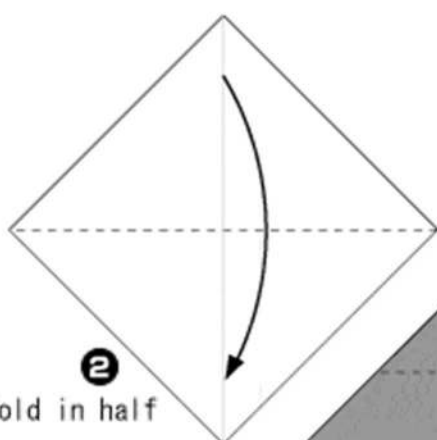

2
Fold in half

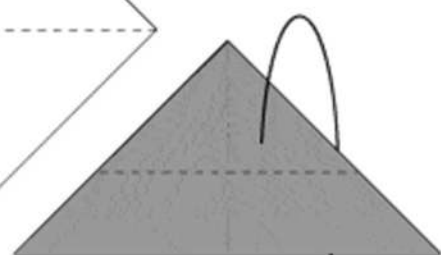

3 Fold backward in the dotted line

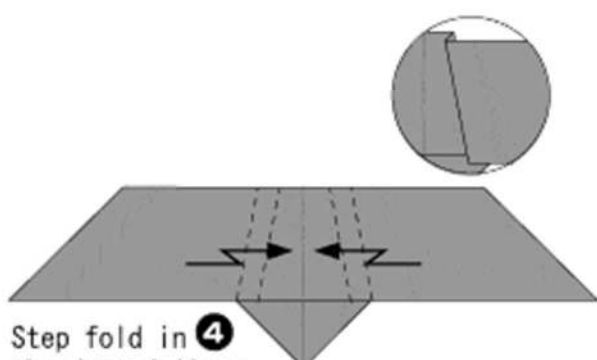

Step fold in **4**
the dotted lines

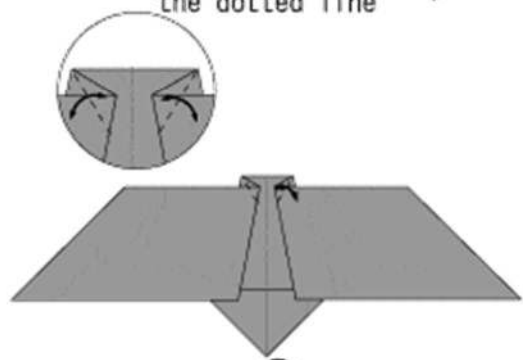

5 Fold to make crease and fold back

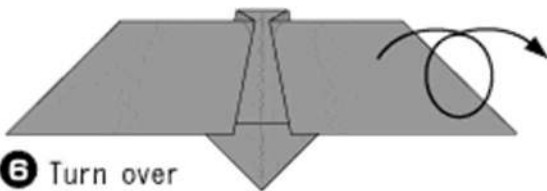

6 Turn over

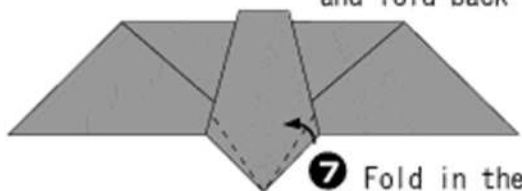

7 Fold in the dotted lines

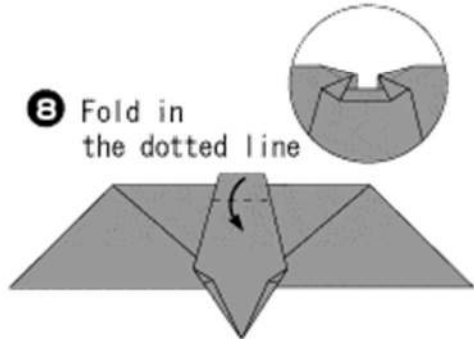

8 Fold in the dotted line

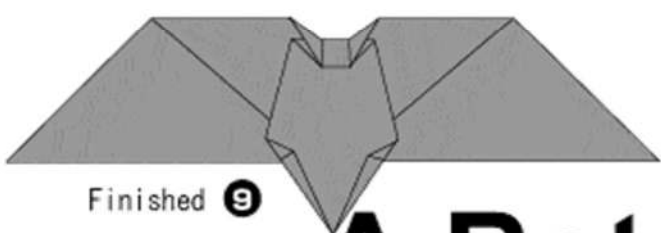

Finished **9**

A Bat